

ELECTRONIC SCALE **WB-150MA**

Instruction manual

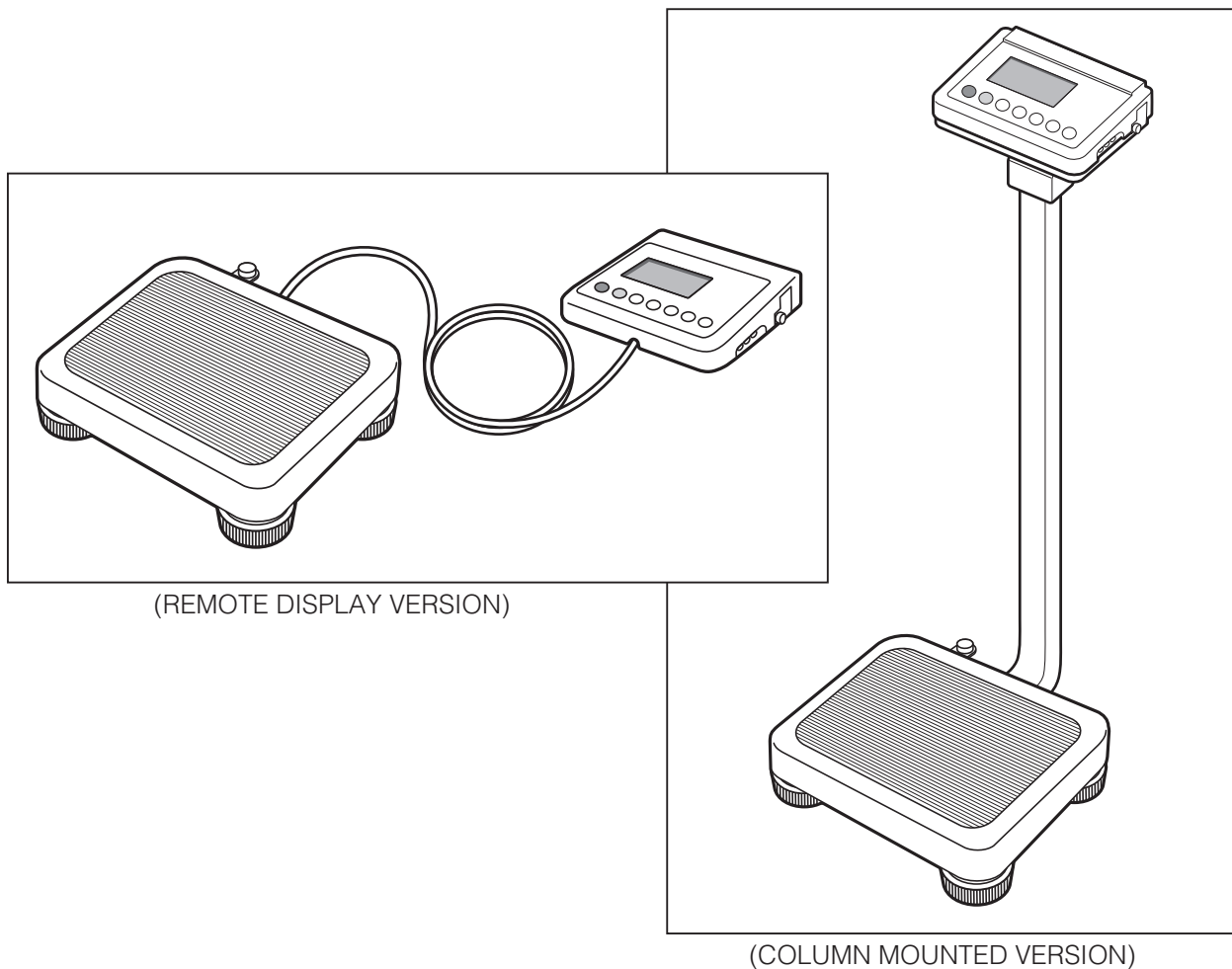

<Usage Conditions>

Temperature	: 5°C – 35°C
Relative Humidity	: 30% – 80% (no condensation)
Maximum Altitude	: 3,000m ASL
Pressure	: 86kPa – 106kPa

<Storage Conditions>

Temperature	: -10°C – 60°C
Relative Humidity	: 10% – 90% (no condensation)

To avoid malfunctions, avoid storing the equipment in a location that is subject to direct sunlight, significant temperature changes, dampness, large amounts of dust, the risk of vibration or impact, or near naked flames.



Please read this Instruction Manual carefully and keep it for future reference.

Intended use

- This equipment has been calibrated as a precision weighing instrument and can be used to certify weights and/or business transactions.
- It can be used to obtain reference data during medical examinations, such as periodic checkups, and can help the prevention of obesity.

Efficiency

Measurements can be taken quickly and easily, causing minimal inconvenience to the patient during measurements.

Contents

Before use

For Your Safety	4
1.Product Assembly and Components	8
Product Components	8
Remote Display Version	8
Column Mounted Version	8
Control Panel	9
Symbols and their Meanings	9
2.Preparation for Use	10
Level Adjustment	10
Installation of the Equipment (Remote Display Version)	10
Installation of the Equipment (Column mounted version)	11
Preparing the Power Supply	12

How to use

3.Operating Instructions	13
Preparation (Automatic power-off to save battery life)	13
Preparation (Weight Lock Mode)	14
Preparation (Confirmation Software Version Number)	14
Measuring Weight	15

When needed





4.Output Data Format	18
5.Troubleshooting	19
Specifications	20

For Your Safety



This section explains precautionary measures to be taken to avoid injury to the users of this device and others, and to prevent damage to property. Please familiarise yourself with this contents to ensure safe operation of this equipment.

GB

Before use
(For Your Safety)

	Warning	Failure to follow instructions highlighted with this mark could result in death or severe injury.
	Caution	Failure to follow instructions highlighted with this mark could result in injury or damage to property.
		This mark indicates actions that are prohibited.
		This mark indicates instructions that must always be followed.

Warning

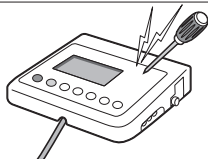
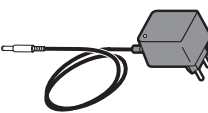
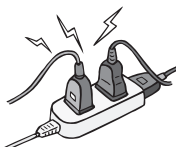
 Warning	Do not handle the plug with wet hands. Doing so may result in electric shock, fire, or leakage.	
	Keep this equipment away from flammable gas and oxygen-rich environments.	
	Do not modify this equipment in any way. Doing so may cause electric shock or injury, or affect the accuracy of analysis.	
	Use only a correctly wired outlet. Only genuine cables and equipment can be used.	
	Do not use a multi-plug adapter. Doing so may cause fire.	

Caution



Prohibited

Keep away from water.

Do not jump on the equipment.

Do not insert fingers into gaps or holes.

Do not apply force to the display.

The screen panel may break and cause injury.



Always...

Ensure that the batteries are inserted with the correct polarity whenever applicable.

Continually monitor both the user and the equipment for anomalies.

If an anomaly in the user or equipment is discovered, take the appropriate action such as stopping the equipment while ensuring the safety of the user.

When connecting a computer or peripherals, be sure that compliance with IEC60601-1 (EN60601-1) is maintained. If the power is supplied in compliance with IEC60950(EN60950), power must be supplied from a medical isolating transformer. Keep at a minimum distance of 1.5m between each item of equipment during operation.

Ignoring this requirement may result in electric shock to the user or malfunctions of the equipment.

**If the equipment will be out of use for a prolonged period, unplug the AC Adapter from the wall socket.
If the equipment will be out of use for a prolonged period, remove the batteries before storing the equipment.**

The data provided by this equipment should be interpreted by a licensed professional.

Be sure to clean the scale platform with the appropriate disinfectant after each use.

Firmly hold the bottom of the equipment with both hands when moving the equipment.

For Accurate Measurements



Always...

Avoid subjecting the equipment to excessive shocks or vibrations.

Avoid measuring in multiple locations that have greatly differing temperatures.

Doing so may cause inaccurate measurements. Allow the equipment to stand for at least 2 hours before using if it is moved to a new location with a temperature difference of 20°C or more.

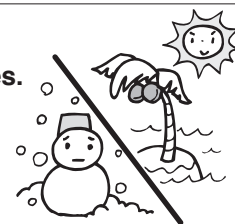

Place the weighing platform on a level and stable surface.

Measurement may not be possible on a surface that is strongly vibrating.

Avoid using near equipment that emits electromagnetic waves.

To ensure accurate measurement, do not touch the user during measurement.

Scheduled Maintenance



Always...

TANITA recommends that each facility conduct periodic checks for each unit.

1. Check the following at least daily:
 - That the unit is on a stable and level surface.
2. Visually inspect the following at least weekly:
 - The display for any damage or contamination
 - All cables, cords, and connector ends for damage or contamination
 - All safety-related labelling for legibility
 - All accessories (sensors, electrodes, etc.) for wear or damage
 - Documentation for the current equipment model
3. Visually inspect the following at least monthly:
 - Screws on equipment

Update settings, replace items, or call for service as necessary based on the results of the visual inspection. Do not use the unit if you see any signs of damage. Equipment that has been damaged must be checked for proper operation by qualified personnel before using again.

Do not wipe the equipment with corrosive chemicals (benzene, cleaner, etc.).

Please use a neutral detergent to clean the equipment.

The warranty will be invalidated if an unauthorised person attempts to disassemble or repair any of the parts of this equipment.

If the equipment malfunctions, please consult your nearest Tanita sales office or agent.

The equipment should be inspected in accordance with the regulations of your country.

Shut Down

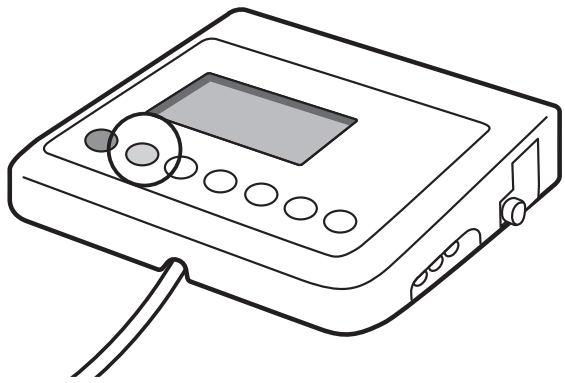

Press the  key.

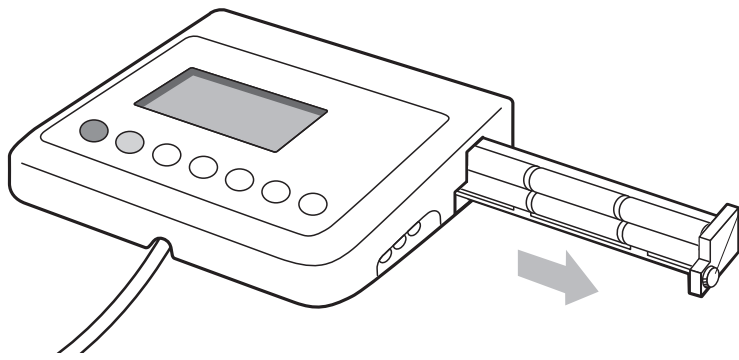

When using dry cell batteries

Loosen the screw to slide the Battery Compartment out

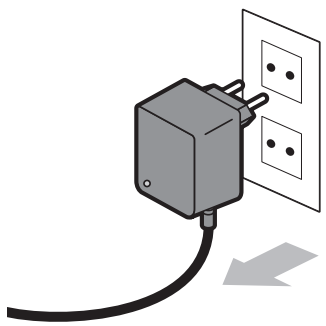

When using the AC Adapter

In case of emergencies, keep the area around the outlet clear while operating this equipment.

1. Product Assembly and Components

GB

Before use
(Product Assembly and Components)

Product Components

Please verify that the following components are in the package.

(Remote Display Version)

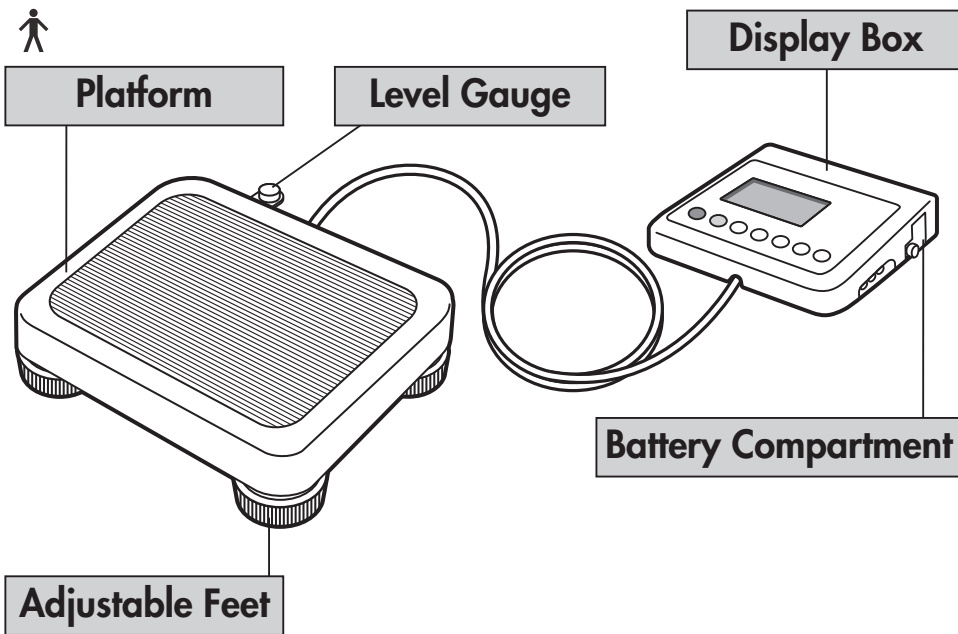

Accessories

AC Adapter
MODEL:FW7333SM/09

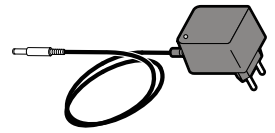

Fixing Screw for
the Bracket (x 2)



Instruction Manual

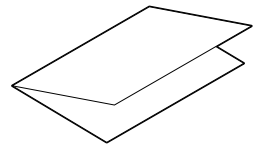

(Column Mounted Version)

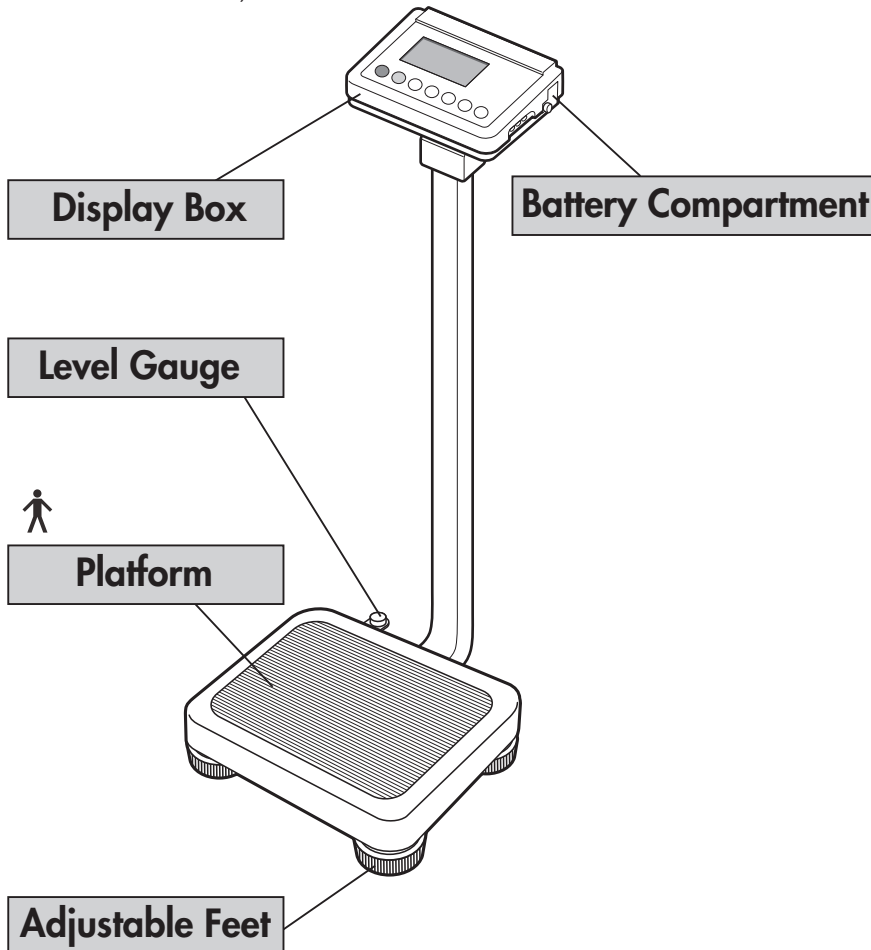

Accessories

AC Adapter
MODEL:FW7333SM/09

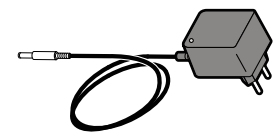

Screws (x 3)



Instruction Manual

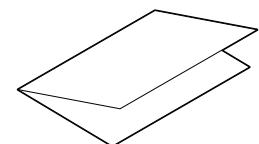

Control Panel

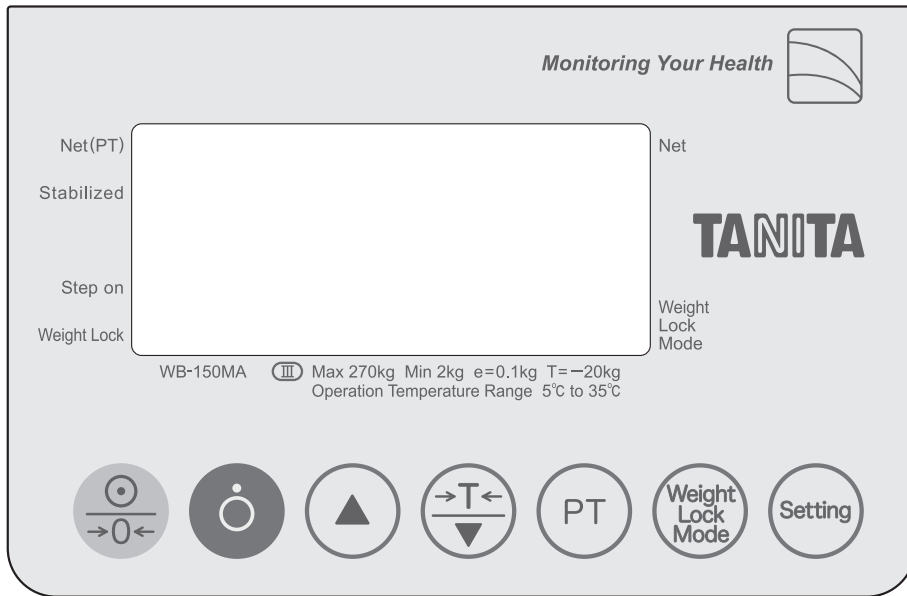

	● Turn power ON / Scale reset to zero		● Input Preset Tare value
	● Turn power OFF		● Turn Weight Lock function ON/OFF
	● Increase numerical value		● Setup various functions
	● Tare / Decrease numerical value		

STEP ON : Start measuring weight.

Net / Net(PT) : Indicates that the tare value is input.

Weight Lock Mode : Indicates that the Weight Lock function is activated.

Weight Lock : Indicates that the Weight is locked.

Stabilized : Indicates that the displayed figure has stabilized.

Symbols and their Meanings

	Power On		Power Off		Tare function
	Zero reset		Conformity with Medical Device Directive 93/42/EEC		Direct current
	Class II Equipment		Type B applied part		Polarity of d.c. power connector
	Polarity of a battery		Date of manufacture		Follow operating instructions
	Alternating current		WEEE - Waste Electrical and Electronic Equipment Directives		Caution Refer to the attached notes.

2.Preparation for Use

GB

Before use
(Product Assembly and Components)

Level Adjustment

(Remote Display Version)

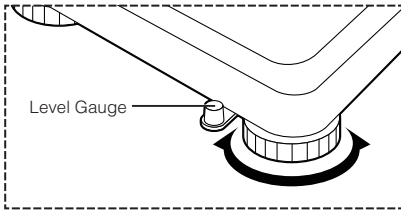

Adjust the level by rotating the adjustable feet.

(Column Mounted Version)

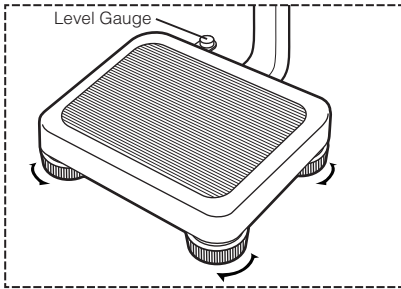

Adjust the level by rotating the adjustable feet.

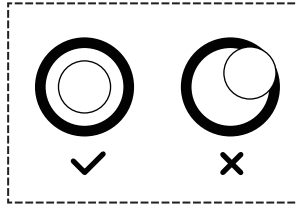

Caution

Place the equipment on a level surface. If the equipment is not stable, for example because not all the feet are on a level surface, there is a risk that it will topple over and it will be impossible to obtain an accurate measurement.

For a column mounted version, adjust the level gauge, then adjust the position of the supplementary feet (small) so that they lightly touch the floor to prevent the display box from shaking.

Installation of the Equipment (Remote Display Version)

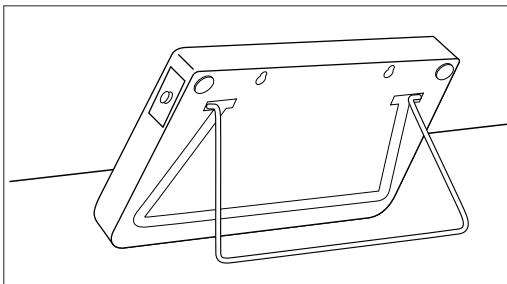

When using the stand

Pull out the stand at the back of the display box. When putting away the display box, insert the stand in the slot on the back of the display box.

When installing the display box on the wall

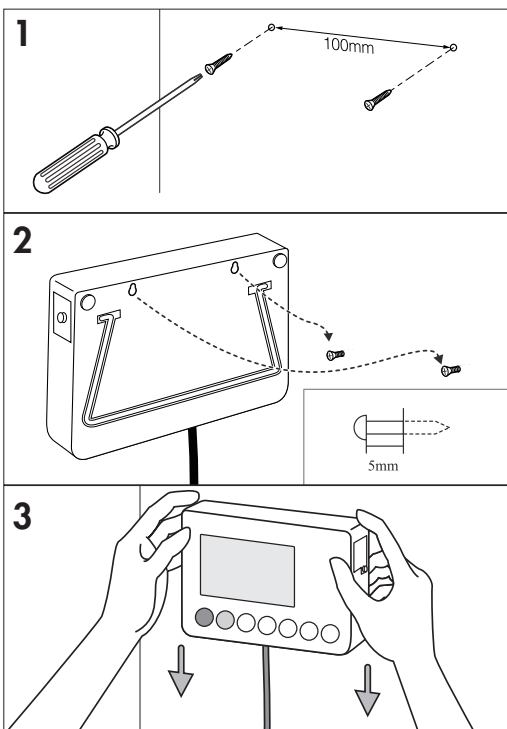

1. Screw the wall-hanging screws into the wall (leave the screws protruding 5 mm from the wall).

2. Insert the screws into the holes on the back of the display box.

3. Pull down the display box securely into place.



- There is a danger that the Display Box may fall down if it is not fixed securely.
- Avoid installing the Display Box in a place where users may step on or get caught by the cable.
- Do not swing the Display Box by the cable.

■ Installation of the Equipment (Column mounted version)

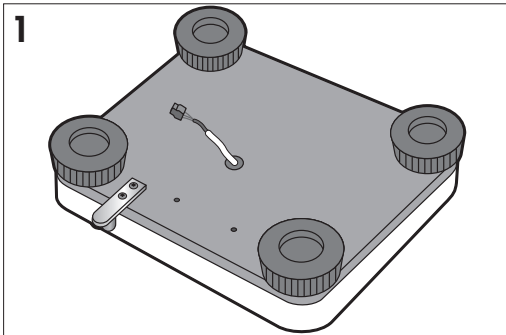

Attach the column to the platform before use.

1. Turn the platform over.

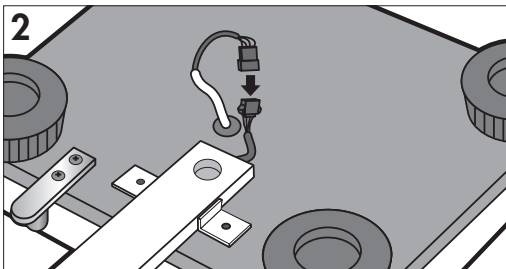

Install the column before use.

2. Connect the connectors on the platform and column.

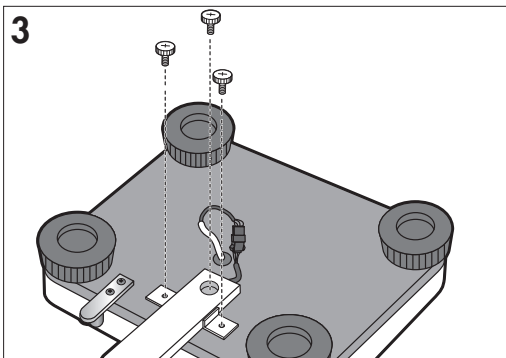

3. Screw the column to the platform using three screws.

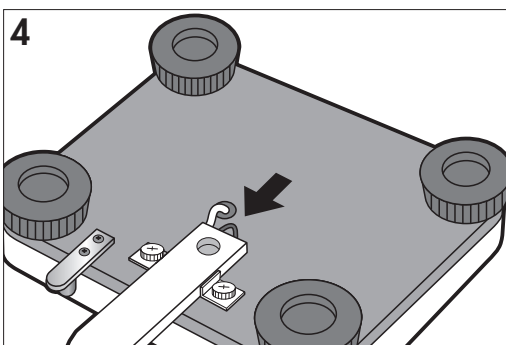

4. Insert the connector into the column.

Note

Ensure that the cable does not become wrapped around the screws.

■ Preparing the Power Supply

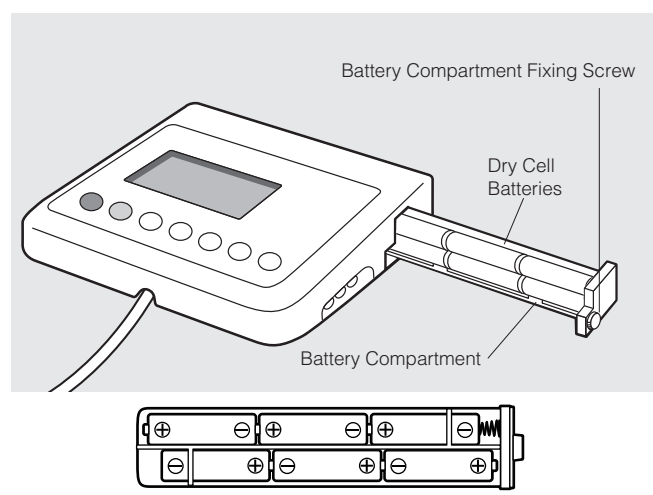
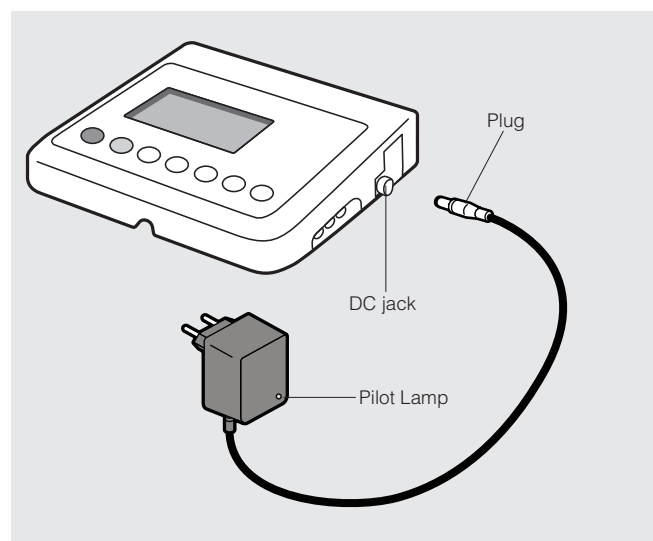

When using the AC Adapter

Insert the AC adapter jack into the DC jack socket of the Display Box, and insert the AC Adapter plug into a wall socket. Check that the Pilot Lamp on the AC Adapter lights.



Warning

To avoid electric shocks, do not insert and remove the plug with wet hands.

Caution

Only use the specified AC adapter (MODEL: FW7333SM/09). Using a different AC Adapter may cause malfunctions.

When using dry cell batteries

Unscrew the Fixing Screws for the Battery Compartment on the right side of the Display Box and pull out the Battery Compartment. Insert six LR6 (AA) dry cell batteries in the correct positions as shown inside the Battery Compartment and fix the Battery Compartment with the Fixing Screws. If  is displayed on the Display, please replace all the six batteries LR6 (AA) with new ones.  appears when the battery voltage is lower than 6.5 V $\pm 10\%$.

- Be careful not to drop the batteries on your feet when changing the LR6 (AA) batteries.
- Ensure that the batteries are inserted with the correct polarity. If the polarity is incorrect, the batteries may leak and damage the equipment.
- Remove the batteries before storing the equipment if it is not to be used for a long time.

3. Operating Instructions

■ Preparation (Automatic power-off to save battery life)

This scale has power saving function that automatically turns the power off after a specified time. Set the power-off time in advance when using this function.

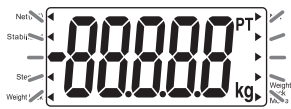

1. Turn on the power by pressing .

After flashes, is displayed.



2. Press when there is nothing on the scale. is displayed.

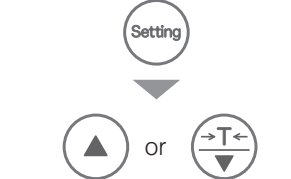

3. Press while is displayed,

and select the automatic power-off time by pressing or .

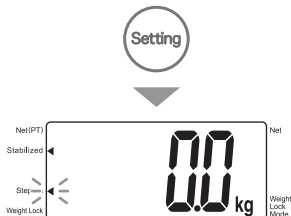



4. After selecting the automatic power-off time, press to set the input time.

5. When is displayed, the setting is completed.

Preparation (Weight Lock Mode)

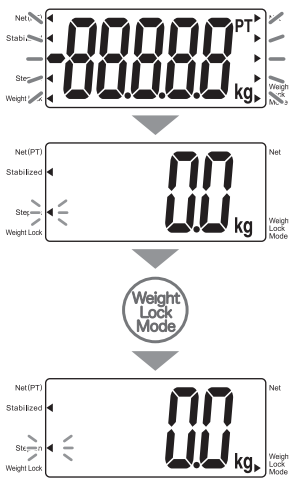
This scale has weight lock function. In order to use this function, enable the "Weight Lock Mode" in advance. When this function is enabled, the display is locked after the weighing value is stabilized.



1. Turn on the power by pressing .

After  flashes,  is displayed.

2. Press the  key to enable weight lock mode.

(This function is disabled when the power is turned on)

When the weight lock mode is enabled,

"Weight Lock Mode" mark is indicated in the display.

3. When the weight lock function is enabled,

the measurement value is locked after the load is stabilized.

When the weight is locked, the "Weight Lock" mark is indicated in the display.

Preparation (Confirmation Software Version Number)

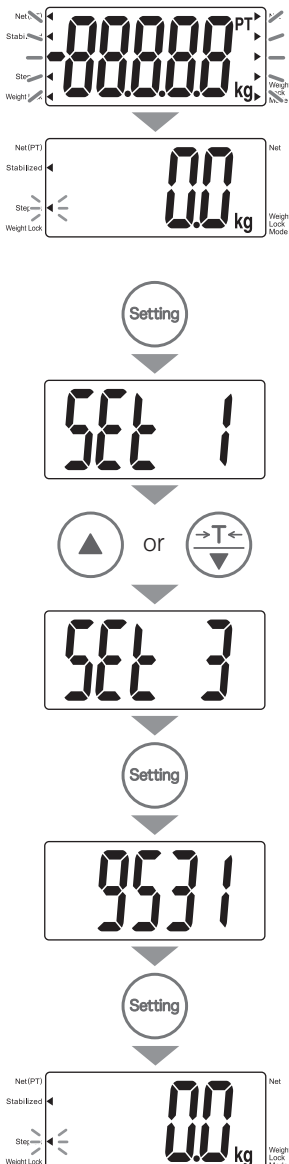

1. Turn on the power by pressing .

After  flashes,  is displayed.

2. Press  when there is nothing on the scale.

 is displayed.

3. Select  by pressing  or . Press .

4. The software version number is displayed.

The number is displayed in order of <Display software> and <AC / DC converter software>

Change the screen by pressing .

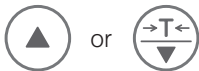
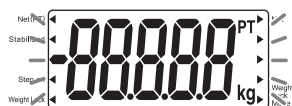

Standard Weighing.

1. Turn on the power by pressing .

After flashes, is displayed.

2. Step on the centre of the platform.

After load is stabilized, "Stabilized" mark is indicated.

3. Step off the scale.

When use <Preset Tare> functions.

1. Turn on the power by pressing .

After flashes, is displayed.

2. Press in no load. "Net (PT)" mark, "PT" mark and flashes.

3. Input preset tare value by or within 20.0kg (0.1kg increments).

Set input preset tare value by .

4. Step on the centre of the platform.



After load is stabilized, "Stabilized" mark is indicated.

5. Step off the scale.

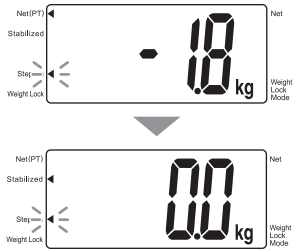
Measuring Weight (continued)





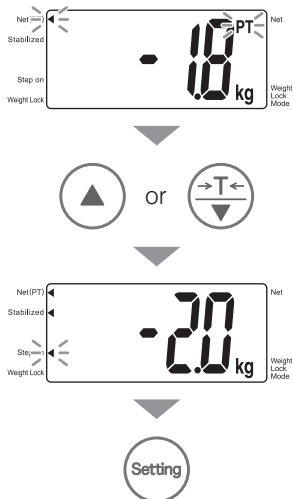

To cancel the <Preset Tare> temporarily

1. Press  in using preset tare.
2. The input preset tare is cancelled temporarily.  is displayed.
When inactivate preset tare function, please set preset tare value to 0.0kg.

To change preset tare value.



1. Press  in using preset tare.
2. Input preset tare value by  or  within 20.0kg (0.1kg increments).
“Net (PT)” mark and “PT” mark are displayed.
Set input preset tare value by .

Tare Weighing

1. Turn on the power by pressing the  key.

After all the segments flash,  is displayed.



2. Carefully place the tare items (clothes, etc.) on the centre of the platform.
The weight of the items will be displayed.

3. Press the  key.
An arrow ►[NET] will appear next to the mark and [0.0kg] will be displayed.

4. When weighing a person/object including tare items, the weight of the person/object minus that of the tare items, which is the net weight, will be displayed.



- To change the tare weight, cancel the tare weighing function and repeat from step 3.
- When using the tare weighing function, the measurement range is reduced by the tare weight.
(Measurement Range) = (Maximum Measurable Weight) – (Tare Weight)

4. Output Data Format

GB

Explanation for RS-232C-compliant output

This explanation is for the interface to output the readings from WB-150MA to external equipment (e.g. PC) as a RS-232C-compliant signal.



When connecting a computer or peripherals, be sure that compliance with IEC60601-1 (EN60601-1) is maintained. If the power is supplied in compliance with IEC60950 (EN60950), power must be supplied from a medical isolating transformer. Keep at a minimum distance of 1.5m between each item of equipment during operation.

Specifications

Communication standard	EIA RS-232C
Communication method	Asynchronous
Signal speed	9,600bps
Data bit length	8bit
Parity	NONE
Stop bit	1bit
Terminator	CR+LF
Flow control	None

Signal line name and connection method

Terminal no.	Signal name
1	
2	TXD
3	
4	
5	GND
6	
7	
8	
9	

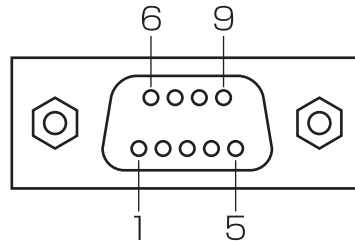

Connection example

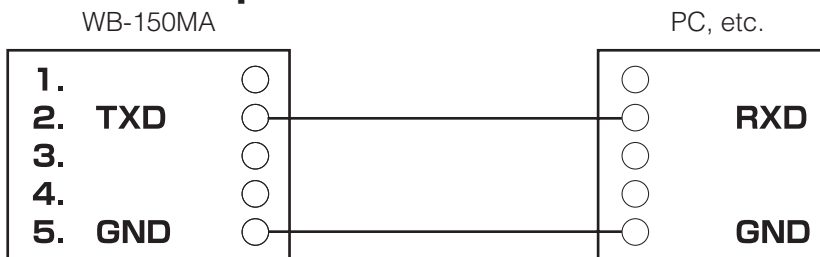

When needed
(cautions for safety)

Transmission data

Transmission data is output immediately after measurement regard-less of the status of the reception side (e.g. PC). Therefore, the reception side must always be ready to receive data before any measurements are taken.

When the display is held

Item	Header	Output data (ASCII code)	Details
Control data	{0	Fixed at 16	
Control data	~0	Fixed at 1	
Model No.	MO	"XXXXXX"	8 bytes fixed length ("WB-150")
Body weight	Wk	XXXXX	3 - 5 bytes variable length (unit: kg)
Preset tare weight	Pt	XXXX	3 - 4 bytes variable length (unit: kg)
Tare weight	Ta	XXXX	3 - 4 bytes variable length (unit: kg)
Checksum	CS	XX	2 bytes fixed length

```

1 2 3 4 5 6 7 8 9 10 11 12 13 14 15 16 17 18 19 20 21 22 23 24 25 26 27
{ 0 , 1 6 , ~ 0 , 1 , M O , " W B - 1 5 0 " , W k , 6
28 29 30 31 32 33 34 35 36 37 38 39 40 41 42 43 44 45 46 47 48 49 50 51 52
5 . 1 , P t , 1 . 0 , T a , 0 . 0 , C S , 5 F CR LF

```



Note

- Commas (,) are used to separate data.
- Terminator (end of data) is CR (ASCII code: 0DH), LF (ASCII code: 0AH).

5. Troubleshooting

Possible Problems

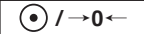
If problems occur, please refer to the following instructions before you ask for repairs.

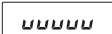
Problem	Solution
The unit does not turn on when the  key is pressed.	<ul style="list-style-type: none"> • When Using with the AC Adapter Ensure that the AC Adapter cable is properly connected with the Display Unit. Ensure that the AC Adapter is correctly inserted in the mains socket. • Using dry cell batteries The batteries may have run out. Confirm that the equipment is working by using the AC Adapter or new batteries.
Measurement is not correct.	<ul style="list-style-type: none"> • Please confirm that all the adjustable feet are resting on a level surface.
Measurement does not become stable. Display turns on and off.	<ul style="list-style-type: none"> • Measurement may be impossible in the case of excessive vibration. Use the equipment in another place.
 is displayed.	<ul style="list-style-type: none"> • It is possible that the maximum weight capacity has been exceeded. Please stop measuring.
 is displayed.	<ul style="list-style-type: none"> • Do not stand on or put objects on the Platform before starting measurement. Start measurement after confirming there is nothing on the Platform.

