

S620A

ELFENBURCHT
 CITADELLE D'ELFES
 ROBIN HOOD'S HIDEOUT
 ELFENBURG
 CASTILLO DE LOS DUENDES
 CASTELLO DEFLI ELFI

Montagehandleiding Notice de montage Assembling manual Montageanleitung Instrucciones para el montaje Istruzioni di installazione

Leeftijd
 Age group
 Age / Alter
 Edad / Età
 6 - 15

EUROPLAY nv
 Eegene 9
 B-9200 DENDERMONDE
 tel. 32.52.22 66 22
 fax.32.52.22 67 22
 www.euoplay.eu

Dat.: 28/06/2018

Rev.: -

Page: 1/6

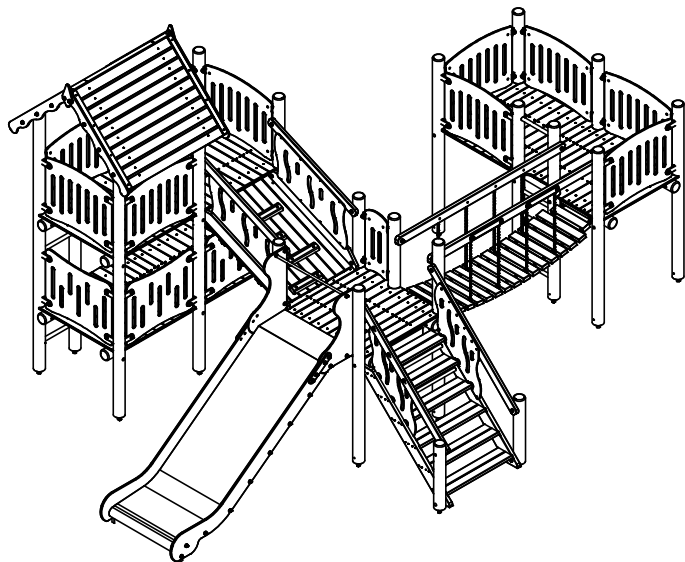

1035kg

VALHOOGTE / HAUTEUR DE CHUTE /
 FALL HEIGHT / FALLHÖHE/
 ALTURA DE CAÍDA / ALTEZZA DI CADUTA

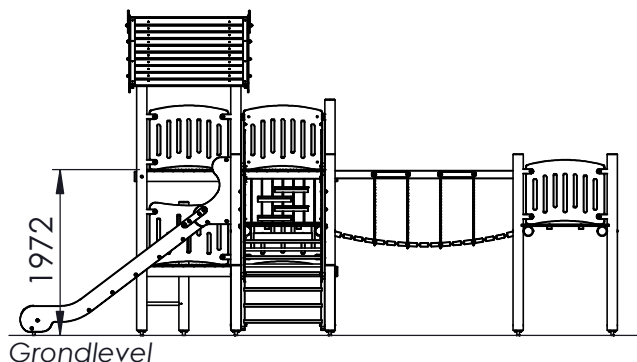

VEILIGHEIDSAFSTAND / ESPACE DE CHUTE / SAFETY AREA /
 SICHERHEITSAFSTAND / ZONA DE SEGURIDAD / DISTANZA DI SICUREZZA

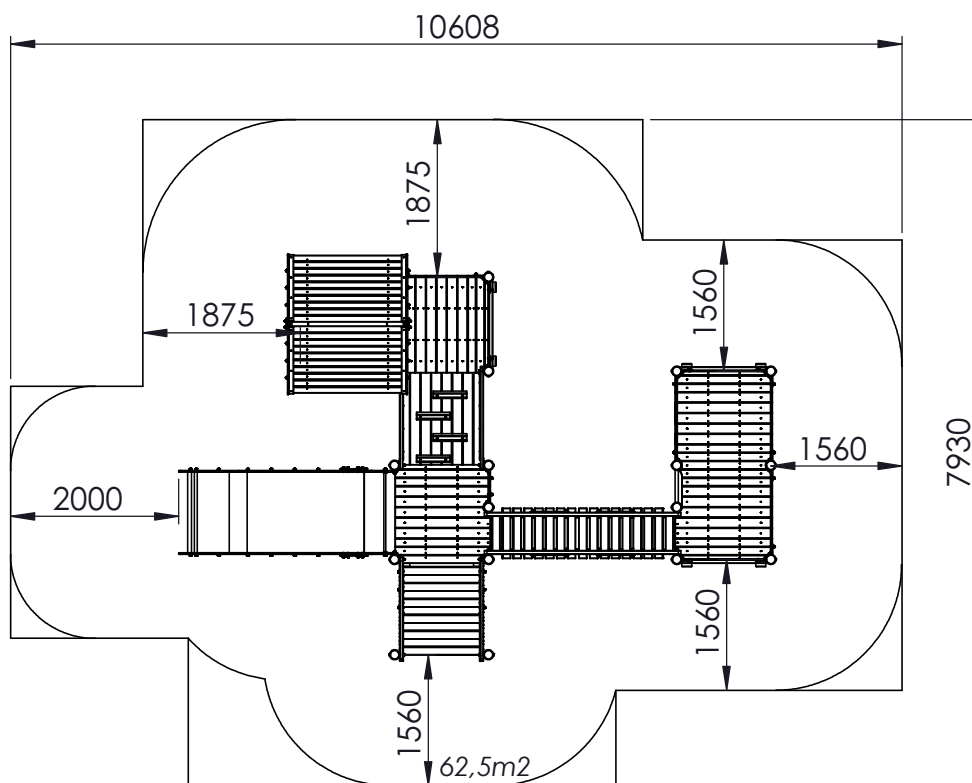

AFMETINGEN
 DIMENSIONS
 MASSE
 DIMENSIONES
 DIMENSIONI
 L: 7,2m
 Br: 4,9m
 H: 3,9m

67,5m²

Benodigdheden - Liste des pièces - Materials - Benötigtes - Accesorios - Requisiti

1x **S620A** BASIC

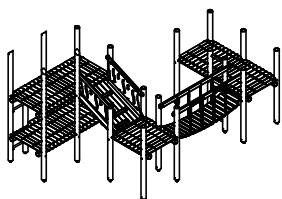
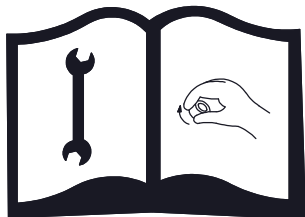

1x **G112A**

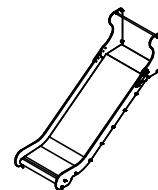
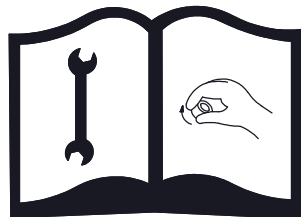

1x **L710A**

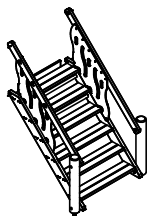
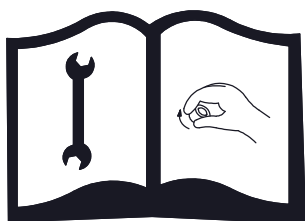

1x **L771**

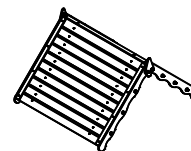
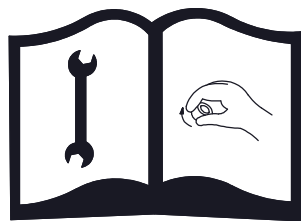

10x **L740**

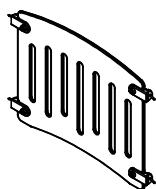
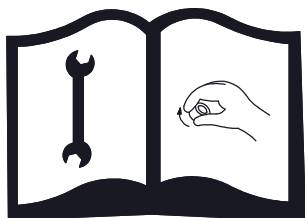

1x **L742**

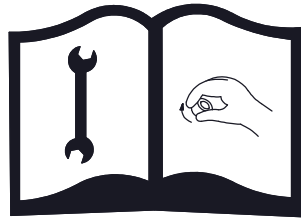

5x **L763**

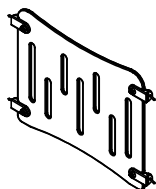
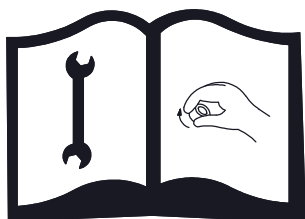

①

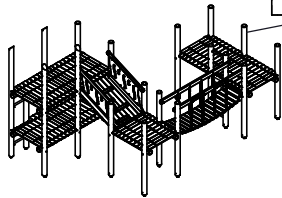
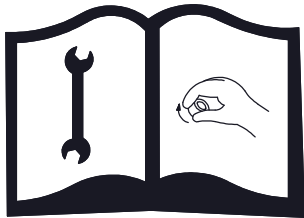
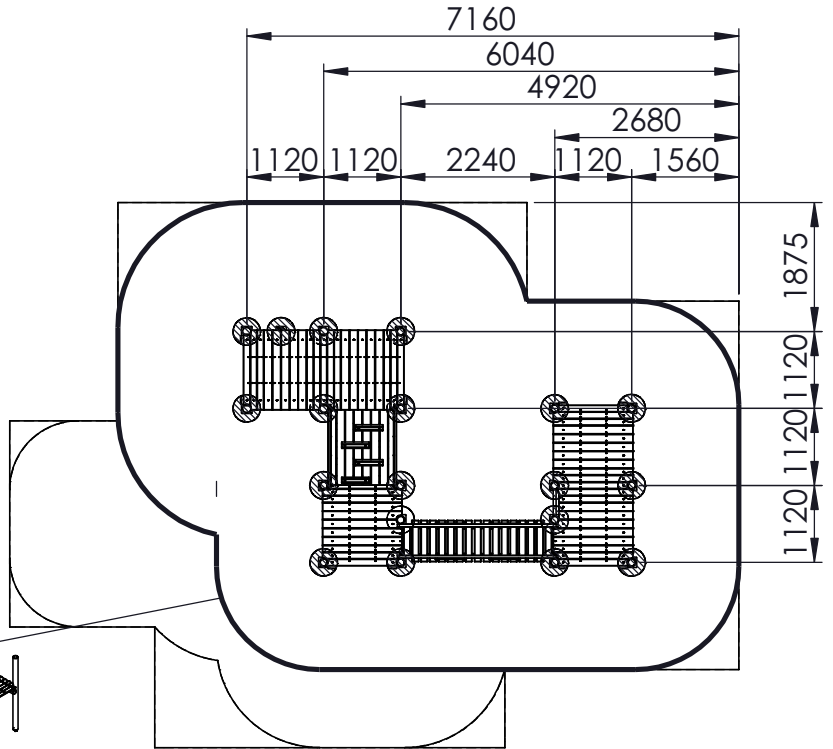
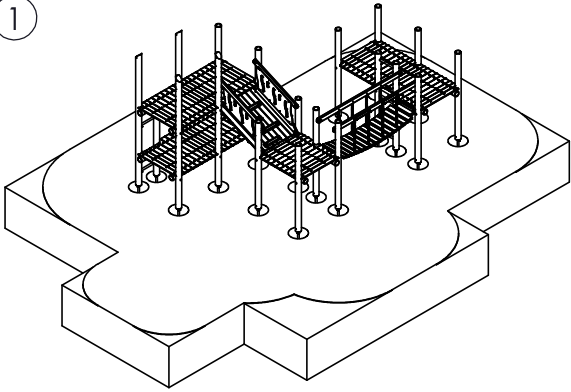

S620A BASIC

① → ⑥ ~~⑦~~ → ~~⑩~~

②

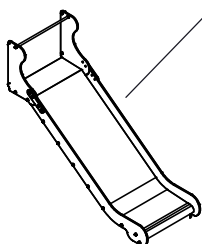
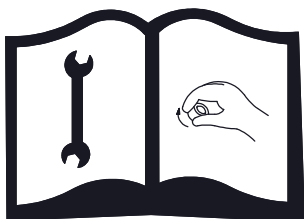
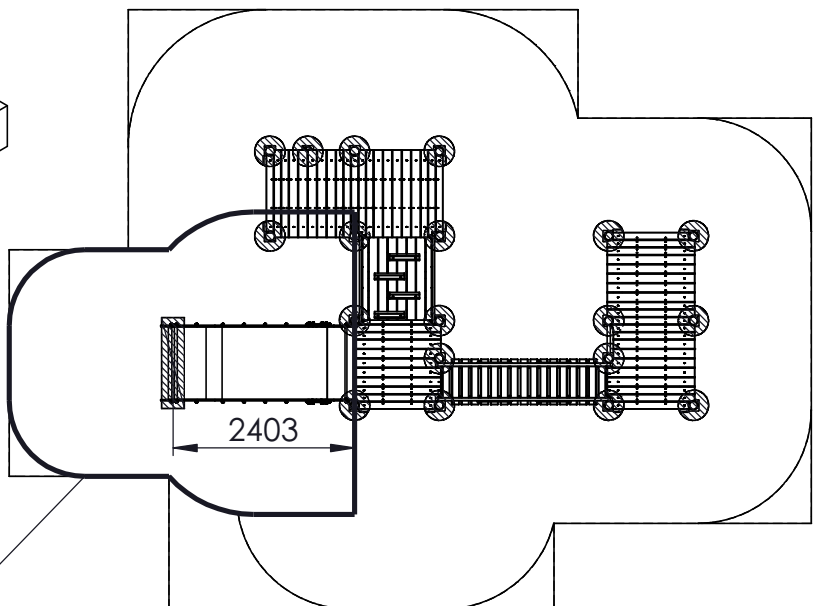
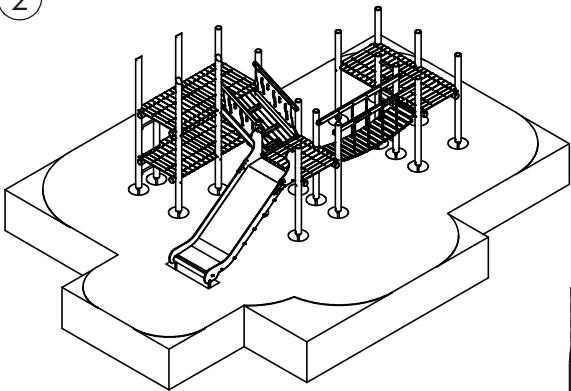

G112A

① → ③ ~~④~~ → ~~⑤~~

3

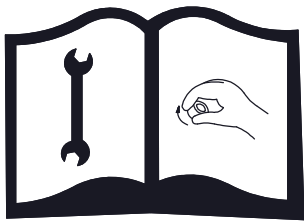
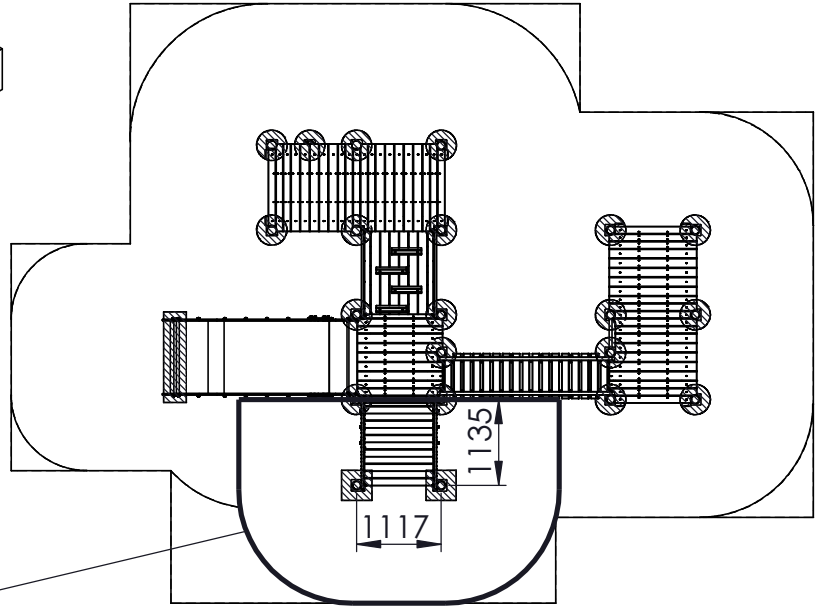
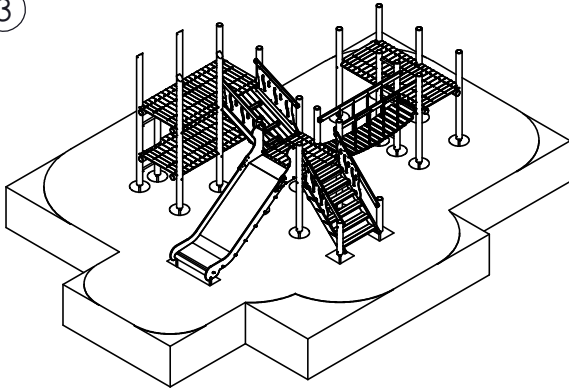

L710A

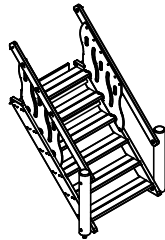

1 → 9 ~~10~~ → ~~11~~

4

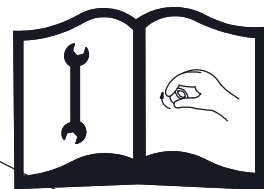
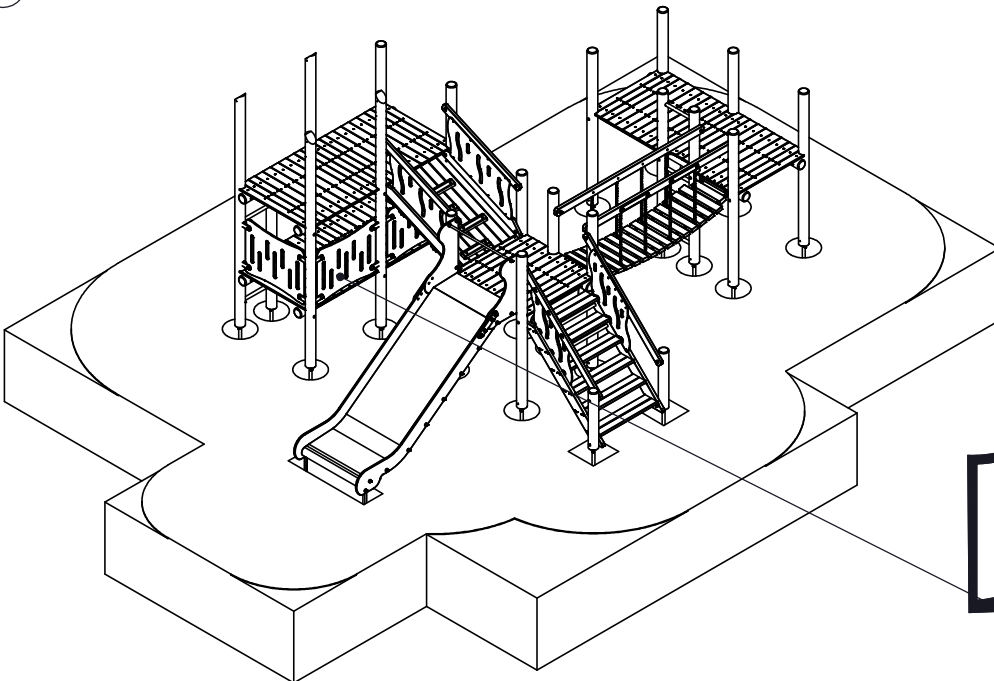

L763
5x

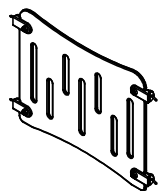

5

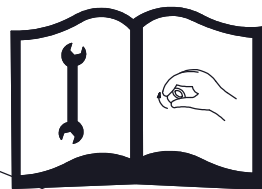
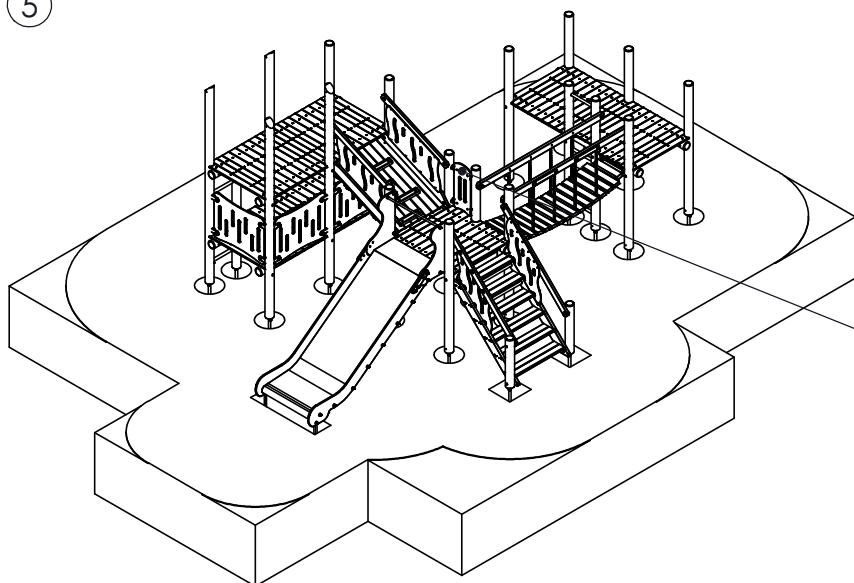

L742
1x

6

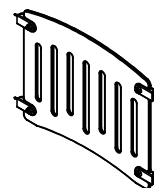
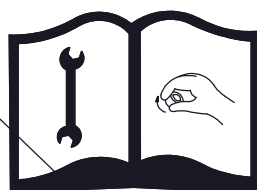
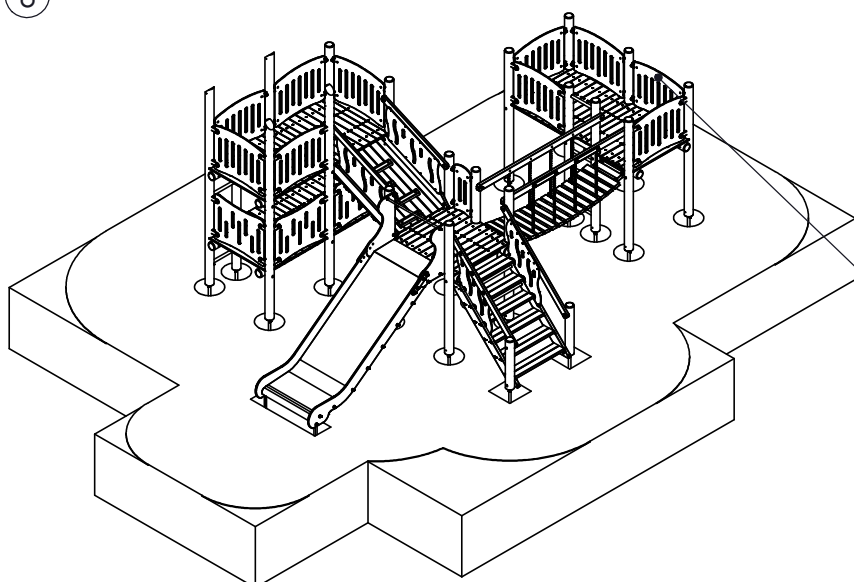

L740
10x

7

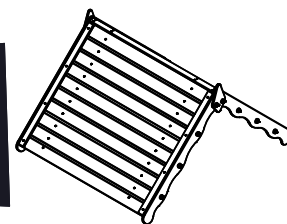
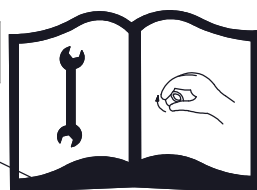
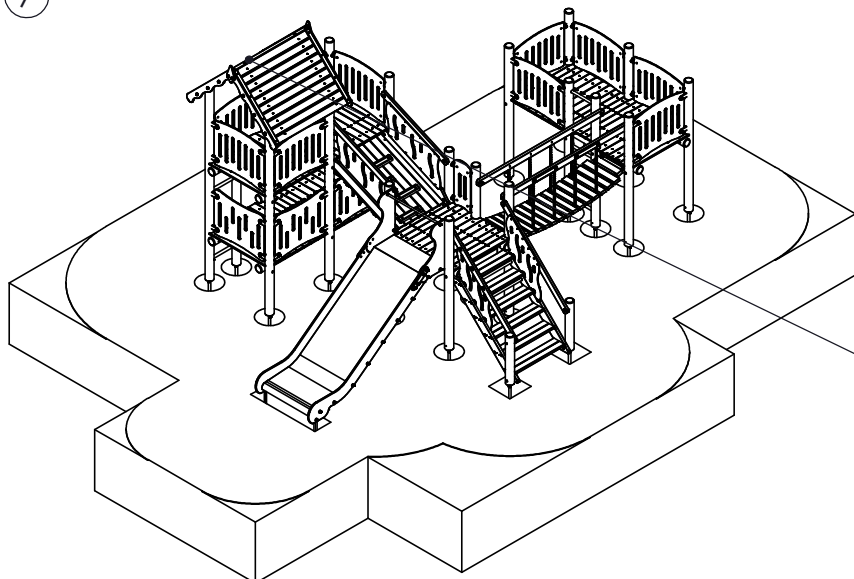

L771
1x

8

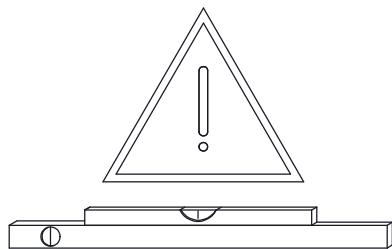

9

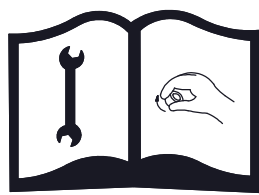

S620A BASIC

① → ⑥ ⑦ → ⑩

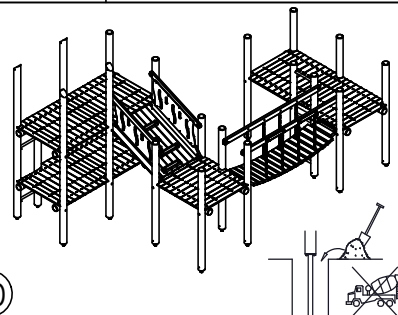

10

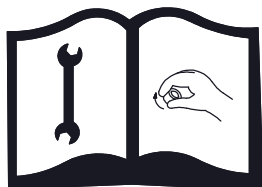

L710A

① → ⑨ ⑩ → ⑪

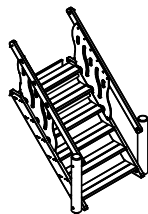

11

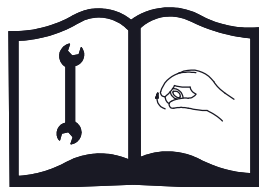

G112A

① → ③ ④ → ⑤

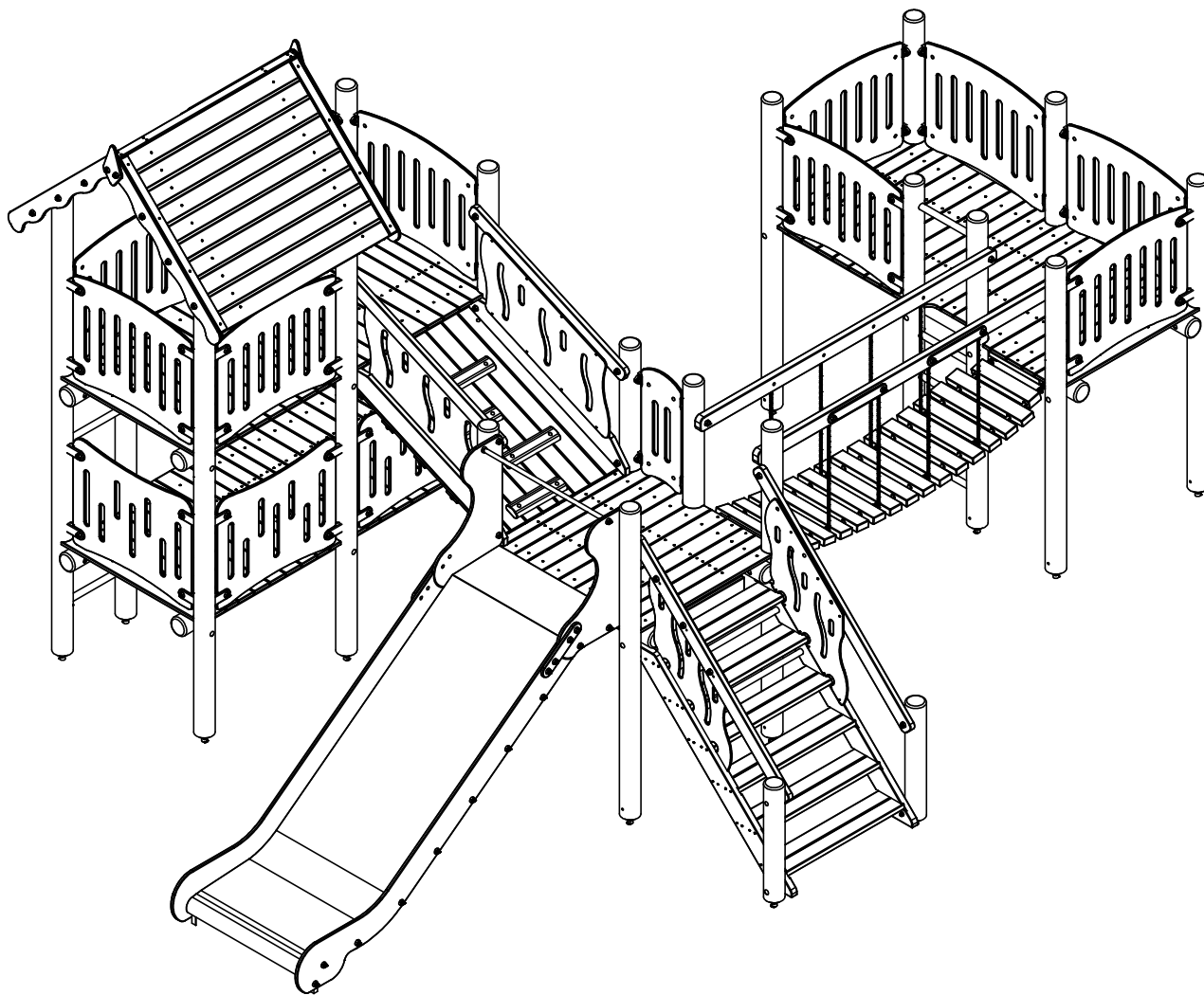
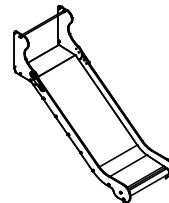

12

Bij droog weer moeten alle bouten en schroeven opnieuw aangespannen worden.
 Par temps sec il faut resserrer régulièrement toute la visserie.

By dry and warm weather check the tightness of all bolts and screws.

Bei trockenem Wetter müssen alle Schrauben und Bolzen aufs neue angespannt werden.
 Para el tiempo seco, se necesita cerrar o ajustar los tornillos y tuercas.

Con tempo asciutto, tutti i bulloni e le viti devono essere avvitate nuovamente.